



More Precision

thermoMETER // Non-contact infrared temperature sensors



Fully integrated compact pyrometer thermoMETER FI

Temperature measuring range
from -40 to 1100 °C

Short response time of 20 ms

Freely scalable voltage output

Open-collector output with 200 mA

No cooling required for ambient
temperatures up to 80 °C

Best price/performance ratio – ideal
for OEM series applications

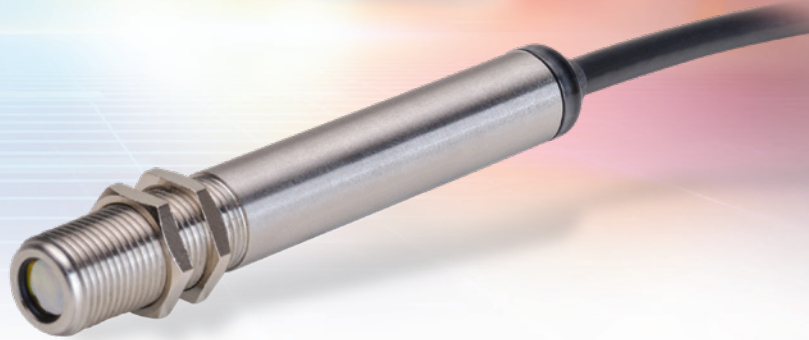

All-in-one pyrometer for OEM and series

The thermoMETER FI is a fully integrated pyrometer for non-contact temperature measurement up to 1100 °C in industrial applications. It is characterized by its extremely compact design, as the sensor and controller are combined in one housing. Its first-class price-performance ratio makes the sensor ideal for series production and OEM use.

Small sensor, great performance

The compact sensor is easy to integrate and ready for immediate use due to preset parameters. Optionally, the sensor can be connected to a PC via USB and individually parameterized. Both extensive signal processing functions and output and alarm settings are available via the sensorTOOL.



Model		FI-SF15
Optical resolution		15:1
Measuring range ^[1]		-40 °C up to 600 °C (1100 °C)
Spectral range		8 to 14 μm
System accuracy ^{[2] [3] [4]}		±1.5 % or ±1.5 °C
Repeatability ^[2]		±0.75 % or ±0.75 °C
Temperature resolution (NETD) ^[5]		50 mK
Response time ^[6]		20 ms
Emissivity		0.100 to 1.100
Transmittance		0.100 to 1.100
Signal processing		Intelligent averaging, Min/Max, Hold function with threshold/hysteresis (adjustable via software)
Supply voltage		5 ... 30 VDC
Max. current consumption		< 6 mA (without LED) / < 20 mA (with LED)
Digital interface		3.3V-LVTTL or USB via programming adapter
Analog output ^[7]		0 ... 5 V / 0 ... 10 V (freely scalable within the measuring range)
Switching output		Open collector for alarm; 200 mA
Connection		Integrated cable with open ends (ferrules); standard length 1 m; optional 3 m, 8 m, 15 m
Mounting		Direct fastening via integrated M12x1 thread or fastening using the hexagon nut included in the scope of delivery
Temperature range	Storage	-40 ... 85 °C
	Operation	-20 ... 80 °C
Humidity		10 % RH ... 95 % RH (non-condensing)
Shock (DIN EN 60068-2-27)		50g, 11 ms, each axis
Vibration (DIN EN 60068-2-6)		3g, 11 to 200 Hz, each axis
Protection class (DIN EN 60529)		IP63
Material		Stainless steel (1.4404)
Weight		approx. 60 g (without cable)
Control and indicator elements ^[8]		Green and red LED (status, alarm and alignment aid) Sensor configuration optionally possible via sensorTOOL

^[1] Measuring range can optionally be extended to 1100 °C

^[2] Valid for object temperatures > 0 °C and at an ambient temperature of 24 °C ±2 °C.

^[3] At 5 VDC; for higher VDC values, ±2 °C or ±2% applies, whichever is greater (ε = 1).

^[4] Valid for object temperatures > ambient temperature; for object temperatures > 200 °C, an additional temperature coefficient of 0.05 K/°C or 0.05 %/°C applies; otherwise 0.15 K/°C or 0.15 %/°C applies; whichever is greater shall apply.

^[5] With a time constant of 200 ms and an object temperature of 200 °C

^[6] 0 - 90 % energy; adjustable via software

^[7] depends on supply voltage

^[8] Access with sensorTOOL requires USB adapter (see accessories)

Product identification

FI-	SF15-	C3
		Cable length: 1 m (standard) / 3 m / 8 m / 15 m
		Focus: SF15
Series: thermoMETER FI		

Standard Focus (in mm)								
SF15	15:1	6.5	11.5	14	18	23.5	29.5	35.5
Distance		0	100	200	300	400	500	600
Close Focus (when using the screwable CF lens, in mm)								
CF15	15:1	6.5	3.7	0.8	4.4	8.1	11.8	15.4
Distance		0	5	10	15	20	25	30

 = smallest spot size / focal point (mm)

The ratio D:S (example 15:1, see table) describes the ratio Distance (distance from the front edge of the sensor to the measuring object) to Spot size (measurement spot size).

Technical drawings

thermoMETER

thermoMETER UC

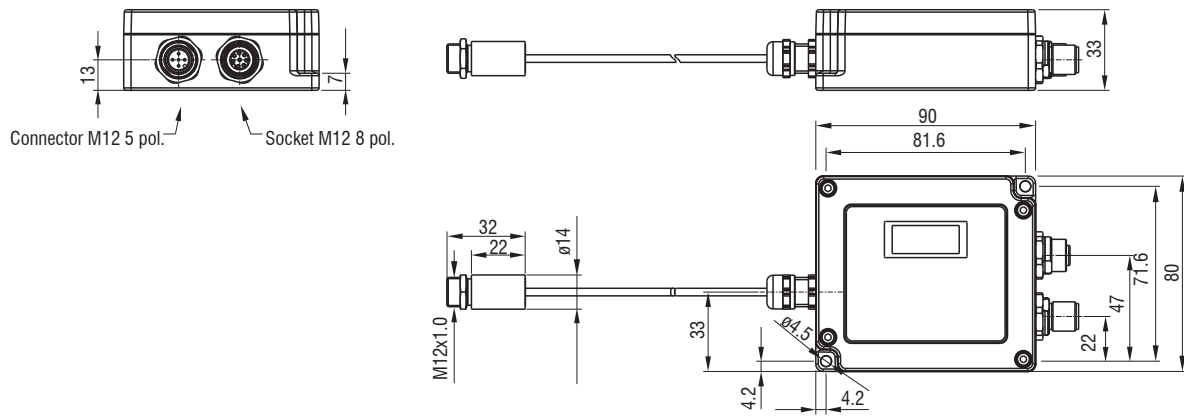

thermoMETER SE

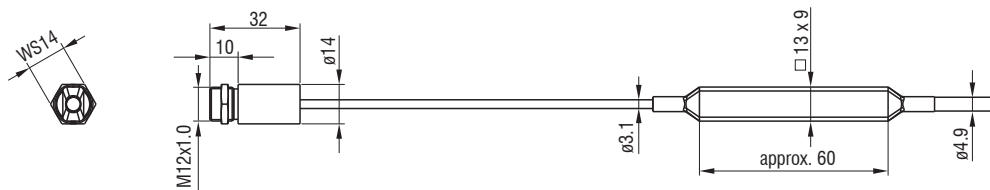

thermoMETER FI

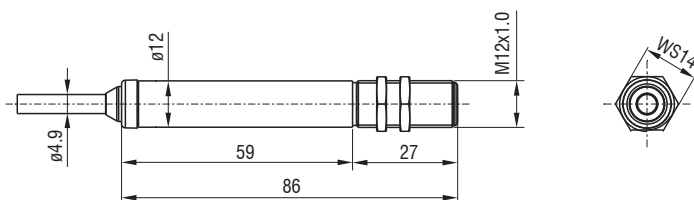





(dimensions in mm, not to scale)

Connection possibilities

thermoMETER





Sensor	Cables	Type
thermoMETER FI	Integrated cable Length 1 m / 3 m / 8 m / 15 m	Open ends (with ferrules)



Connection possibilities and accessories	
Connection supply voltage PS2020	
USB programming adapter for connection to PC TM-USBA USB adapter with terminal block	
Interface module for Ethernet and EtherCAT connection IF1032	
Control / machine Analog output (voltage), open collector	









Sensor	Cables	Type
thermoMETER SE	Sensor cable (sensor controller) Lengths 0.5 m / 3 m / 6 m / 15 m Connection cable (Controller - open ends) Lengths 0.5 m / 3 m	Open ends (with ferrules)



Connection possibilities and accessories	
Connection supply voltage PS2020	
USB programming adapter for connection to PC TM-USBA USB adapter with terminal block	
Interface module for Ethernet and EtherCAT connection IF1032	
Control / machine Analog output (current/voltage), open collector	

Sensor	Cables	Type
thermoMETER UC	Digital cable: TM-DC8/x-M12 Lengths 1 m / 5 m	Open ends (with ferrules)
	Digital cable: TM-USBA-M12 Length 1.8 m	USB
	Analog cable: TM-PC5/x-M12 Lengths 1 m / 5 m	Open ends (with ferrules)



Connection possibilities and accessories	
Connection supply voltage PS2020	
USB programming adapter for connection to PC TM-USBA USB adapter with terminal block	
Control / machine 2x alarm relays, RS485	
Interface module for Industrial Ethernet connection IF2035-PROFINET IF2035-EIP IF2035-EtherCAT	
Connection to PC (sensorTOOL) Display & parameter setting	
Interface module for Ethernet and EtherCAT connection IF1032	
Connection supply voltage PS2020	
Control / machine Analog output (current/voltage)	

Mounting accessories / optical accessories / air purge collars

Art. no.	Name		FI	SE	UC
2970750	TM-DIN-UC	Rail mount adapter	⊗	⊗	✓
2970751	TM-MF-UC	Mounting fork	⊗	✓	✓
2970752	TM-APL	Air purge collar, laminar	✓	✓	✓
2970753	TM-FB	Mounting bracket	✓	✓	✓
2970754	TM-AB-UC	Mounting bracket, adjustable in 2 axes	⊗	✓	✓
2970755	TM-MB-UC	Mounting bolt with M12x1 thread and nut	⊗	✓	✓
2970756	TM-TA	Pipe adapter	✓	✓	✓
2970757	TM-T40	Reflection protection tube, length 40 mm; M12x1 external thread	✓	✓	✓
2970758	TM-T88	Reflection protection tube, length 88 mm; M12x1 external thread	✓	✓	✓
2970759	TM-T20	Reflection protection tube, length 20 mm; M12x1 external thread	✓	✓	✓
2970760	TM-MH-UC	Massive housing made from stainless steel	⊗	✓	✓
2970761	TM-FBMH-UC	Mounting bracket for solid housing	⊗	✓	✓
2970762	TM-APMH-UC	Air purge collar made from stainless steel for solid housing	⊗	✓	✓
2970763	TM-CF	Close Focus lens	✓	✓	✓
2970764	TM-PW	Protective window	✓	✓	✓
2970765	TM-AP-UC	Air purge collar (stainless steel) for lenses from D/S 15:1	⊗	⊗	✓
2970766	TM-AP2-UC	Air purge collar (stainless steel) for lenses with D/S 2:1	⊗	⊗	✓
2970767	TM-AP	Air purge collar	✓	✓	✓
2970768	TM-AP8	Air purge collar with 8 mm hose connection	✓	✓	✓
2970769	TM-MI	Right angle mirror	✓	✓	✓

Connection cables for pyrometer UC

2904051	TM-PC5/1-M12	Analog signal and supply cable 1 m
2904052	TM-PC5/5-M12	Analog signal and supply cable 5 m
2904053	TM-USBA-M12	Digital signal cable with USB converter, 1.8 m, M12 plug, USB-A plug
2904054	TM-DC8/1-M12	Digital signal cable, 1 m, M12 plug, ferrules, pre-assembled
2904055	TM-DC8/5-M12	Digital signal cable, 5 m, M12 plug, ferrules, pre-assembled

USB adapter for pyrometers UC / FI / SE

2970770	TM-USBA	USB adapter with terminal block
---------	---------	---------------------------------

IF2035: Interface module for Industrial Ethernet connection

- Connection of RS422 or RS485 interfaces to PROFINET / Ethernet/IP / EtherCAT
- Synchronization output for RS422 sensors
- 2 network connections for different network topologies
- Data rate up to 4 MBaud
- 4-fold oversampling (with EtherCAT)
- Ideal for confined spaces due to a compact housing and DIN rail mounting

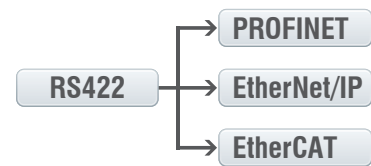

IF1032: Interface module for Ethernet & EtherCAT connection

- Connection of analog output or RS485 to Ethernet and EtherCAT
- Web interface for data display and scaling
- CSV export



Sensors and Systems from Micro-Epsilon



Sensors and systems for displacement, distance and position



Sensors and measurement devices for non-contact temperature measurement

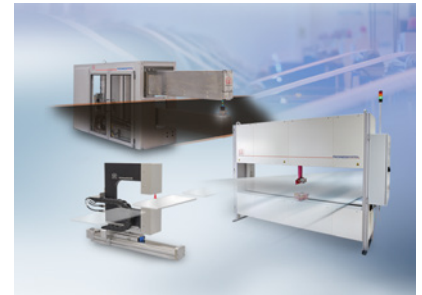

Measuring and inspection systems for metal strips, plastics and rubber



Optical micrometers and fiber optics, measuring and test amplifiers



Color recognition sensors, LED analyzers and inline color spectrometers

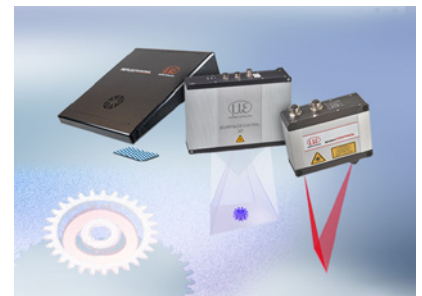

3D measurement technology for dimensional testing and surface inspection